



Universal interfacial layer measuring device

MIQ 8130/8260 mipromex®



- Universal for batch separation and continuous interfacial layer measurement
- Evaluation for impedance probes
- Plug & Process for batch operation
- 2. Measuring point for product monitoring
- Menu guidance in 3 languages
- Commissioning procedure
- DIN rail or wall mounting

Use

The aquasant® universal interfacial layer measuring device can be used in batch or continuous operation.

In continuous separators, mipromex® regulates the liquid-liquid layer separation with bar or pipe probes after the bottom valve. The changing measured value is visualised on the PCS via the analogue output. In continuous operation the interfacial layer height is monitored and regulated, during batch separation the boundary layer can be detected with high precision. Two digital outputs are available for low-level indication and for control of the automatic dynamic interfacial detection.



Overview

- ▼ MIQ 8110: 1 measuring circuit with 1 active analogue output and 2 limit values (OC)
- ▼ MIQ 8130: 1 measuring circuit with 1 active analogue output and 2 limit values (relay)
- ▼ MIQ 8260: 2 measuring circuits with 1 active analogue output each; measuring circuit 1 with 2 limit values (relay); measuring circuit 2 for product monitoring

- Dynamic interface detection for batch separation
- **Continuous interfacial layer measurement**
- Parameterisation in languages: D / F / E
- Device data and item no. storage
- Film keypad with graphic display
- 19" plug-in cartridge 3 HE/12 TE (European format)
- Supply: 24 V DC/AC 50/60 Hz; independent of polarity
- Analogue output: 4-20 mA with galvanic isolation, max. load 750 Ohm active (non-Ex)
- Fault message programmable on analogue output
- Fault indication Time/Date
- 2 LV relay outputs max. 2A/30VDC
- mA output and limit value simulation
- 1 or 2 measurement inputs for transmitter modules, max. cable length approx. 200 m (<120 nF)
- 256 kB Flash Firmware V1.x

Ex version: Gas II (2) G [Ex ia Gb] IIC
 Staub II (2) D [Ex ia Db] IIIC
 Gas (2) D [Ex d ia] IIC

SEV 09 ATEX 0132; EMC STS 024 CE 1254

Basic function

The pulse signal transmitted from the aquasant® transmitter module is converted into an offset-compensated, filtered pulse value. The interfacial layer is measured in function of the calculated measuring span. For batch separation with automatic dynamic interfacial layer detection, limit value output 2 is available for quick, high-precision detection. The measured value progression can be visualised via the analogue signal. For continuous operation, the level of the mipromex® MIQ is adjusted. The interfacial layer height is measured in function of the calculated measuring span in accordance with the saved parameter set. The indication is shown on the display as pulse, % value or mA output signal, and the limit value outputs are depicted in - output signal fail-safe status. The measuring span corresponds to the interfacial layer progression within the length of the measuring electrode from

0–100%. The 4-20 mA analogue output can be spread, if necessary, by means of programmable start and end value percentage. A corresponding sequence is available for commissioning.

Parameter entries are menu-guided and mipromex® type-dependent.

As well as the analogue signal, 2 relays each are available on the first measuring circuit with adjustable fail-safe setting for Low and High function, as well as programmable on/off time delay. Error messages are visualised with time, date and error type.

For the MIQ 8260, a second measurement input is available for layer monitoring or fill level of upper layer. It is visualised via a separate analogue signal.

Measuring circuit

A measuring probe with MTI transmitter module in the probe head is connected to the mipromex® MIQ by means of a shielded 2-core cable. A potential equalisation line must be installed between the earthing of the plant room and the control room.

Measuring principle

Impedance measurement; dependent on electrical conductivity and dielectric constant.

Wiring

2-core cable 0.75 mm² twisted CY/EIG, cable length up to 200 m or max. C= 120 nF / R = 30 Ohm line impedance

Connection

All aquasant® on-site electronic units for impedance measurement can be connected.

Function change

Level: Continuous level measuring with analogue output and two limit values (OC) for Low/High

Detection: Automatic-dynamic batch separation with readjustment

Function

The electrode system of a probe, surrounded by product, changes the impedance in function of the dielectric properties and conductivity of organic products and aqueous solutions. The measured impedance sum signal is converted directly by the aquasant® transmitter module into a normed signal and is transmitted as pulse packages to the analogue transmitter mipromex® MIQ.

The measured value in the range normed by Aquasant Messtechnik AG (0–3700 pulses) is product-specific and varies in function of interfacial layer height, product mixes or immersion depth. The physical measured impedance value of a product at a given interfacial layer height or immersion depth is thus displayed as a numeric value, which is designated as a pulse count.

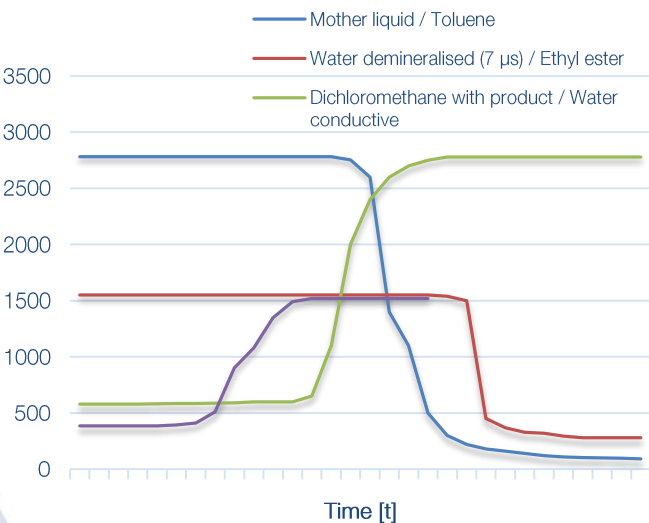

Batch separation

Aquasant® measured value monitoring detects the product change and low-level indication fully automatically with the highest precision. The interfacial layer is measured with a pipe or bar probe, which is installed in the discharge line after the bottom valve of a reactor or storage tank.

Automatic-dynamic batch separation

The mipromex® MIQ automatic-dynamic interfacial detection works independent of the product-specific signal progression, rising or falling. Based on the set sensitivity, the interfacial layer is detected in function of the measured value change from the lower to the upper layer. Via 3 digital inputs (start command), 7 different sensitivity adjustments can be selected using BCD coding.

Digital output 2 of the MIQ can control the separation valve directly or via process control system. The start command is issued directly by the PCS when the bottom valve is opened. The measurement can be interrupted at any time. The signal progression is monitored and documented via the analogue output.

Measured value progression (image left):

....active.

Readjustment (image below):

If the starting measured value of the lower layer is reached again within 5 minutes of the interfacial layer detection, the separation valve is opened again and the measurement remains active.

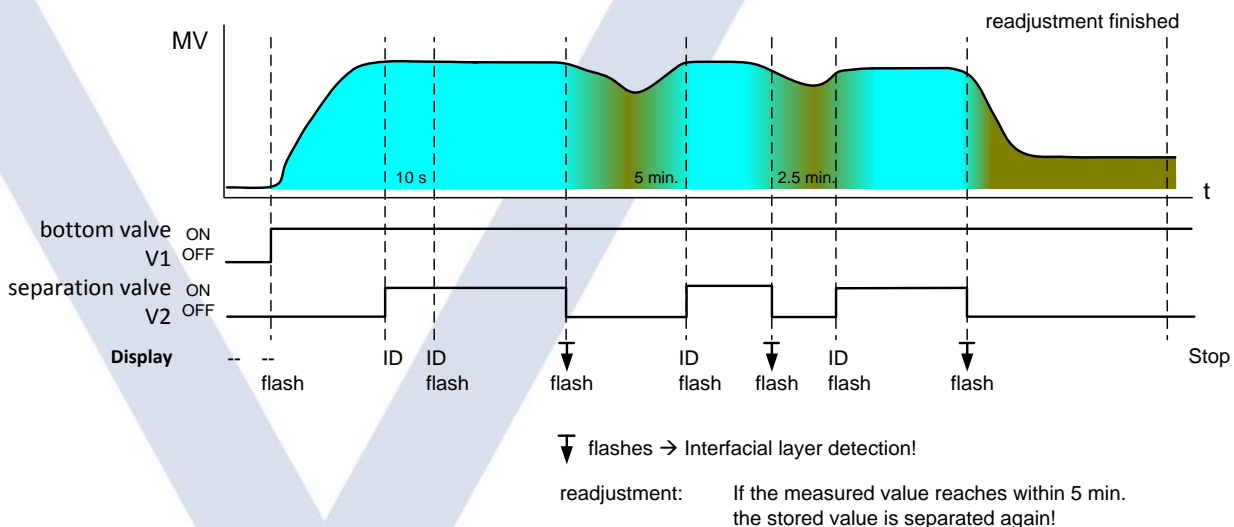

Start: when opening **bottom valve V1**, switch the corresponding digital inputs (D1-D3) to 1 (+24 V)
ID flashes: interfacial detection on; ↓/↑ **flashes** interfacial layer detected; **V2 separation valve** closes (relay 2 = de-energised)

Connection circuit board for 19" rack, Monorack

Cage Clamp® terminals for 0.08–2.5 mm² cable cross section, stripping length 5–6 mm / 0.22 in (without cable end sleeve), are mounted using a special tensioning tool.

Colour coding:

The fail-safe field circuit is connected to the **blue** terminals. It may be guided into the hazardous area with connecting cables as per DIN EN 60079-14.

The **black/orange** terminals are polarity-dependent current inputs and outputs.

Dimensions: H x W x D 137 x 77 x 210 mm / for Eurocard 3 HE/12TE Depth 60 mm

Connection to: mipromex® microprocessor device

Article no.: 02.03.18.011

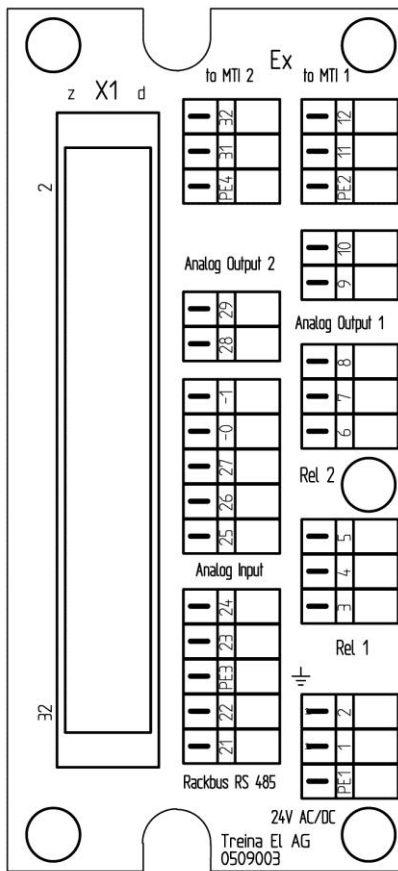

- PE1 earth
- 1. Power supply 24 V AC/DC 50/60 Hz (polarity independent) FI32: d/z6
- 2. Power supply 24 V AC/DC 50/60 Hz (polarity independent) FI32: d30

	Relais	Opto coupler	
3.	1 NO	analog output E-	FI32: z24
4.	1 COM	output C+	FI32: d24
5.	1 NC	-	FI32: z22
6.	2 NO	output E-	FI32: z16
7.	2 COM	output C+	FI32: d16
8.	2 NC	-	FI32: z14

- 9. MK1 analog output 1 - FI32: d14
- 10. MK1 analog output 1 + FI32: z12
- 11. MK1 MTI 1 K1 FI32: z2
- 12. MK1 MTI 1 K2 FI32: d2

- 21. Rackbus RS 485 A FI32: z32
- 22. Rackbus RS 485 B FI32: d32
- 23. analog input - FI32: d18
- 24. analog input + FI32: d12
- 25. digital input 3 (+24 V) FI32: d10
- 26. digital input 2 (+24 V) FI32: z10
- 27. digital input 1 (+24 V) FI32: d8
- 0 digital input D1-3 (0 V) FI32: z8
- 1 digital input D1-3 (0 V) FI32: z8
- 28. MK2 analogue output 2 - FI32: z22
- 29. MK2 analogue output 2 + FI32: z20

- 31. MK2 MTI 2 K1 FI32: z4
- 32. MK2 MTI 2 K2 FI32: d4

Mounting/Installation:

The 19" cartridge is used in a MRM Monorack for DIN rail or wall mounting.

The connection board with FI32 female multi-point connector can also be installed in table-tops or 19" racks. For Ex applications, the connection boards are different (female multi-point connector is coded).

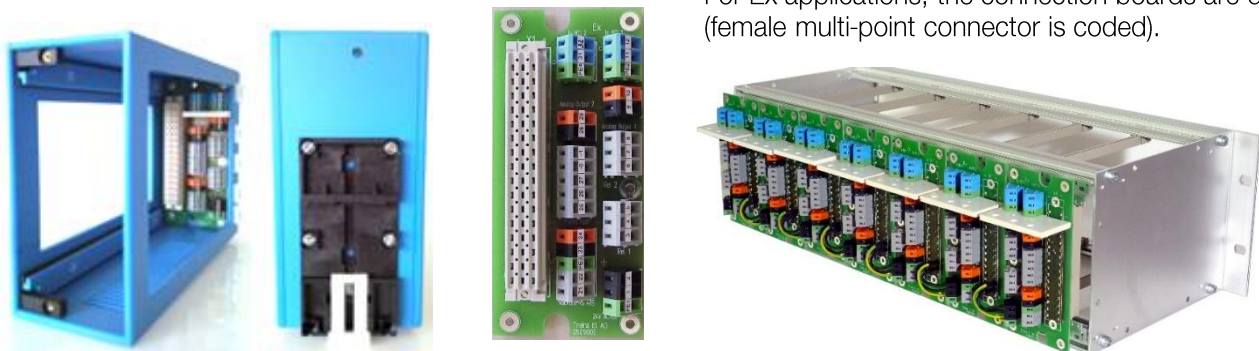

Connections to FI32 female multi-point connector MIQ 8130

Microprocessor device with one measuring circuit input | Connections to FI32 female multi-point connector

Electrical data

Euro plug-in print pin assignment 24 V version

Switchpoint 1 for measuring circuit 1 FSL (Fail Safe Lo) L Alarm
 Relay de-energised (Measured value < Limit value)
 Switchpoint 2 for measuring circuit 1 FSH (Fail Safe Hi) H Alarm
 => for dynamic batch separation, FS setting is inactive
 Relay de-energised (Measured value > Limit value)

Technical error: Switching levels analogue output as per parameterisation, relay de-energised
 Fault message programmable in 0.1 mA increments; 0.5...3.9 / 20.1...22 mA

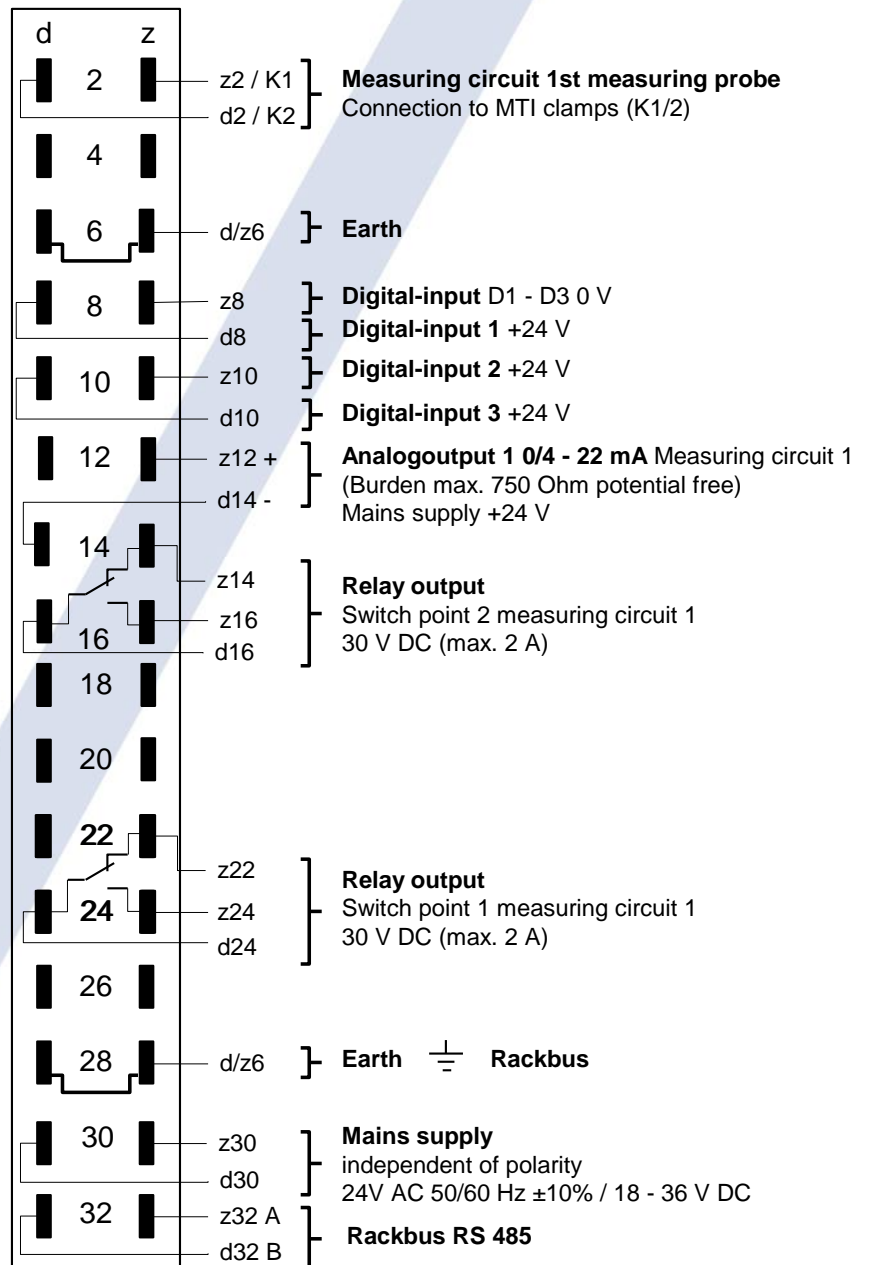

Connections to FI32 female multi-point connector MIQ 8260

Microprocessor device with 2 measuring circuit inputs | Connections to FI32 female multi-point connector

Electrical data

Euro plug-in print pin assignment 24 V version

Switchpoint 1 for measuring circuit 1 FSL (Fail Safe Lo) L Alarm
 Relay de-energised (Measured value < Limit value)
 Switchpoint 2 for measuring circuit 1 FSH (Fail Safe Hi) H Alarm
 => for dynamic batch separation, FS setting is inactive
 Relay de-energised (Measured value > Limit value)

Technical error: Switching levels analogue output as per parameterisation, relay de-energised
 Fault message programmable in 0.1 mA increments; 0.5...3.9 / 20.1...22 mA

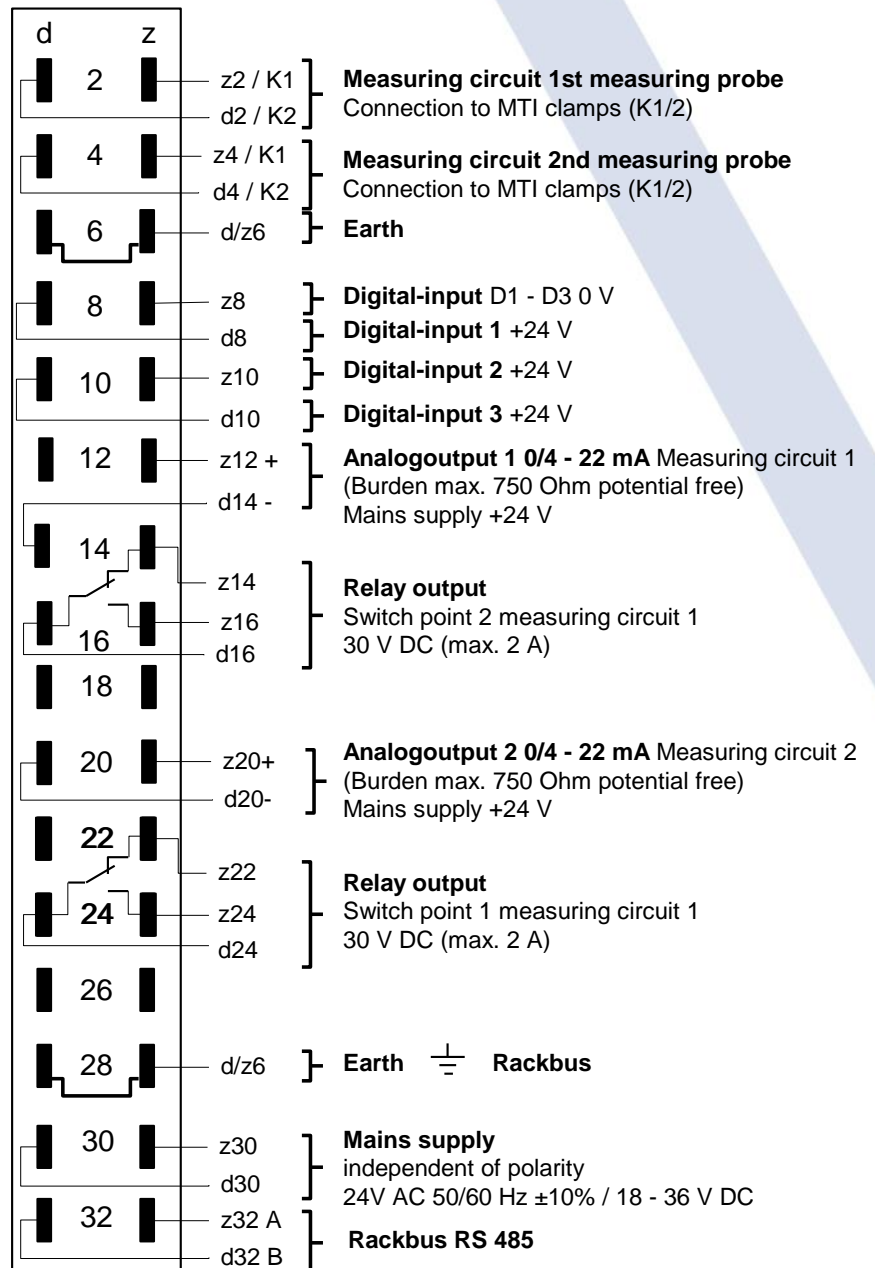

Earthing for microprocessor devices and probes

Earth-related measuring must be earthed in accordance with Ex regulations.

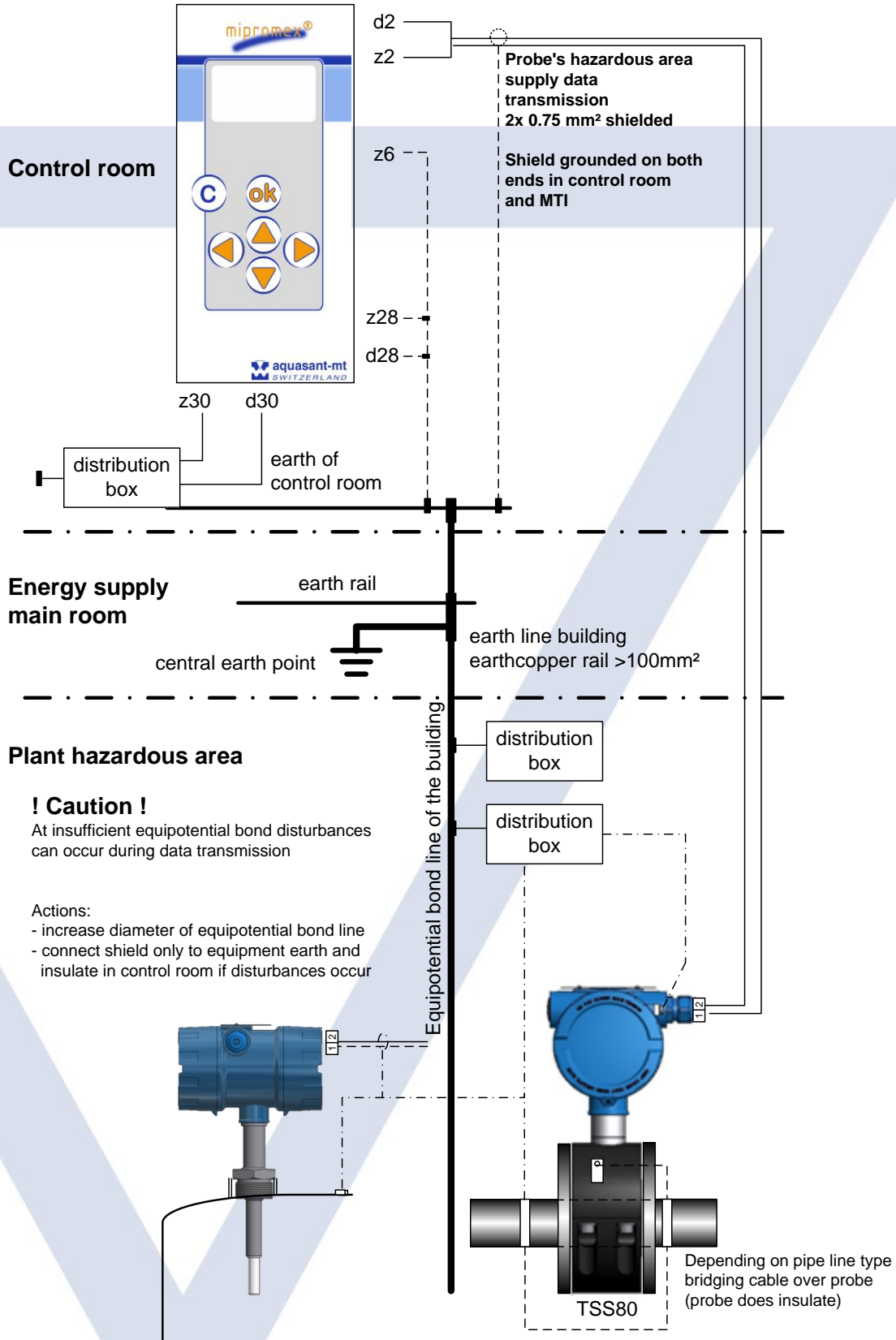

Wiring diagram MRM to process control system

For automatic-dynamic batch separation via PCS

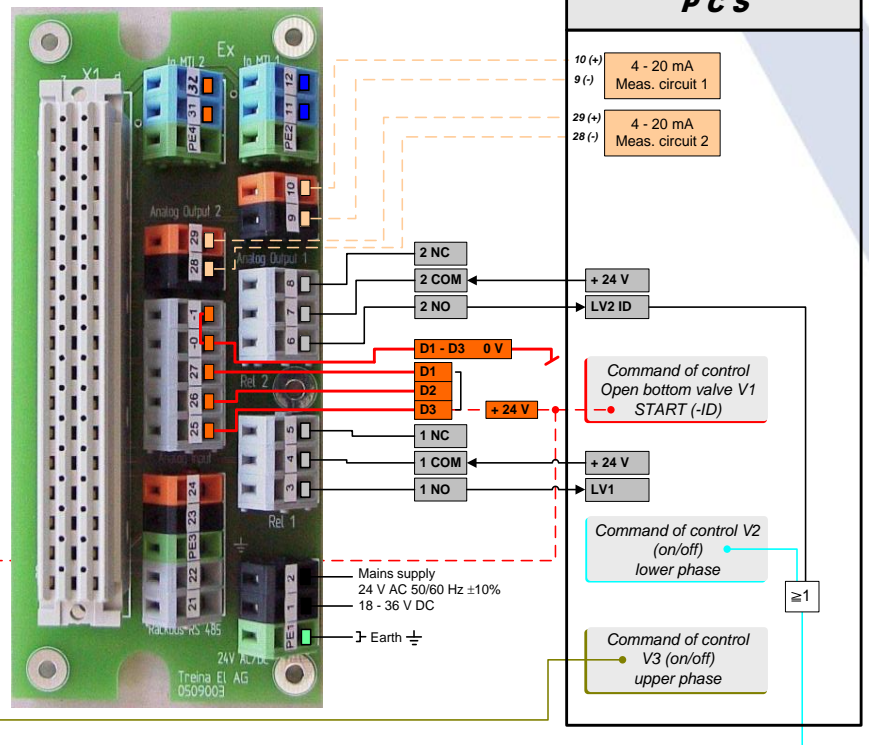
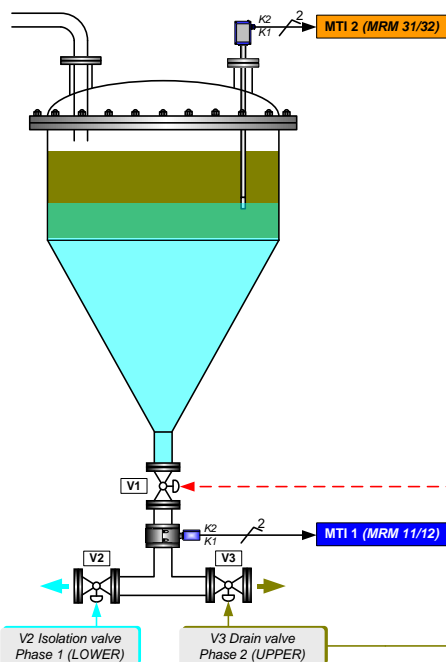
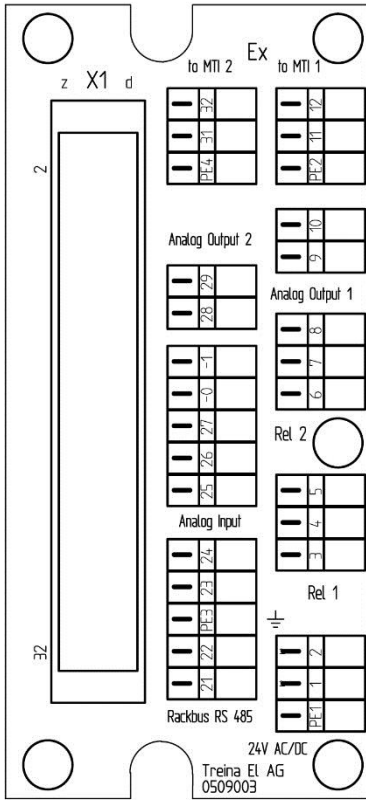

Technical data

Design type

Plug-in electronics with square stainless cover in protective housing, with HF connection

19" plug-in module with aluminium-steel housing; IP 20

Mounting

MR 7 19" rack; 3 HE (European format)

MRM II monorack; plastic housing for DIN rail or wall mounting. Front panel mounting with BOPLA housing.

Compact or table-top for laboratory

Function

Interface layer measuring device with fail-safe supply for one MTI xx measurement transducer.

- Continuous interfacial level measurement
- Dynamic interface detection for batch separation
- Menu-guided multilingual device communication
- Commissioning procedure
- 1 analogue and 2 digital outputs

Operation/Display

Front panel with film keypad with graphic LCD display, backlight, 6 push buttons for entering calibration data and parameters

Data backup in case of mains failure

Battery buffer max. 10 years. Parameter storage in case of battery failure

Dimensions

Heights 3 HE; width 12 TE

Front panel: Height x Width 128 x 61 mm

Plug-in module: Height x Width x Depth 100 x 60 x 160 mm

7 plug-in modules can be mounted per 19" rack

Weight

MIQ 8130: 690 g / MIQ 8130: 705 g

Supply voltage

24 V DC/AC 50/60 Hz / (22-26 V AC) / (18-36 V DC), independent of polarity

Start-up current

Short-time (1 ms) approx. 1 A

Power consumption

MIQ 8130 approx. 3.4 VA (I = 140 mA) / MIQ 8130 approx. 4 VA (I = 200 mA)

Fuses

8.5 x 8.5 mm miniature fuse MST 400 mA

Hazardous area supply/Signal transmission

[Ex ia] IIC, modulated pulse supply signal

Open circuit voltage $U_0 \leq 18.9$ V

Short-circuit current $I_0 \leq 49$ mA

Power $P_0 \leq 231$ mW output characteristic linear

Ex d ia, modulated pulse supply signal

Open circuit voltage $U \leq 19.3$ V

Short-circuit current $I \leq 75$ mA

Signal wiring circuit Ex ia IIC

Max. external inductance $L_0 \leq 10$ mH

Max outer capacity $C_0 \leq 180$ nF



Signal transmission

1 or 2 measuring circuits, modulated pulse supply signal

Signal line short-circuit

max. current consumption MIQ 8110/8130: 160 mA / MIQ 8260: 280 mA

Ambient temperature

0°C – +45°C

Storage temperature

-20°C – +45°C, ideally +20°C

Measuring range / Data display, processing

0 – 3700 pulses / Transmission of MTI 400 ms, internal processing mipromex 20 ms, approx. 3 measurements/second

Switching hysteresis

1 pulse corresponds to 0.028 pF for measuring range 100 pF

Connection

FI male plug 32 poles, coding possible (Ex version)

Relay output

2 relays of 1st Measuring point with one switchover contact for the limit value; example: Min./max. deviation, FSL or FSH safety selectable.

Switching voltage 30 V DC /2 A, I/O=2kV, -40-85 °C

1 relay each for two-channel devices

Switching voltage relay output

30 V DC

Continuous current relay output

2 A

Breaking capacity relay output

60 W

Analogue output

1 active 4–20 mA output, max. load 750 Ω, non-Ex, with potential separation, technical failure 0.5–4 / 20–22 mA adjustable

Interface

RS 232 / RS 485 (only for firmware update)

Monitoring

Self-monitoring measuring system: defective probe, short-circuit/interrupted Ex supply (wire break protection); measuring range; mains failure and mipromex® malfunctions

Testing

	Gas	II (2) G [Ex ia Gb] IIC
	Staub	II (2) D [Ex ia Db] IIIC
		II (2) G / II (2) D (Probe [Ex d ia] IIC)

RL 2014/34/EU

Test report no.: 08-IK-0396.01 with extension 1

Device also available without hazardous area protection mipromex® must be installed outside the hazardous area.

Fail-safe hazardous area connection:

MTI transmitter module ... In protective housing or S**; K**; F** bar probes

EMC-tested, STS 024 Report No. 990102WS

complies with EN 1127-1 : 20011

EN 61000-6-2 2005 EN 6100-6-4 : 2007

EN 60079-0 : 2012 EN 60079-11 : 2012



Fault messages

Error messages are visualised on the display with time, date and error type.

Fault messages can be programmed on the analogue signal in the ranges of 0.5 – 4.0 mA and 20.0 – 22.0 mA, in increments of 0.1 mA.

In the event of a fault, the limit value outputs are de-energised.

Technical error:

All mipromex® microprocessor devices are equipped with a diagnostic system, which facilitates the error search and helps to rectify faults more quickly.

mipromex® technical errors which require the device to be sent to aquasant® for repair:

- ▼ Flash memory checksum verification failed

In the case of repeated errors, send device in for repair!

- ▼ Flash memory failed

Flash is defective; send device in for repair!

- ▼ Low battery: Battery is drained and must be replaced

Battery change; send device in for repair!

- ▼ Program memory check failed

Microprocessor card is defective; send device in for repair!

Data error:

- ▼ Measured value undershot: mA output changes to the value programmed in menu item 8.3! Relays drop out.

Possible cause: Cable break, misaligned on-site MTI electronic unit

- ▼ Measured value exceeded: mA output changes to the value programmed in menu item 8.3! Relays drop out.

Possible cause: Measured value is greater than 3750 pulses, misaligned on-site MTI electronic unit

